



fitbit inspire™



User Manual
Version 2.5

Table of Contents

Get started	5
What's in the box	5
Charge your tracker	5
Set up with your phone	6
See your data in the Fitbit app	7
Wear Inspire	8
Wear Inspire on your wrist	8
Secure the band	8
Handedness	10
Wear Inspire in a clip	10
Clip Placement	11
Wear and care tips	11
Change the band	12
Remove a band	12
Attach a band	12
Basics	14
Navigate Inspire	14
Basic navigation	14
Quick settings	16
Change the clock face	17
Notifications from your phone	18
Set up notifications	18
See incoming notifications	18
Turn off notifications	19
Timekeeping	21
Set an alarm	21
Dismiss or snooze an alarm	22
Use the timer or stopwatch	23

Activity and Wellness	24
See your stats	24
Track a daily activity goal	24
Choose a goal	25
Track your hourly activity	25
Track your exercise automatically	25
Track your sleep	26
Set a sleep goal	26
Learn about your sleep habits	26
Update, Restart, and Erase	27
Update Inspire	27
Restart Inspire	27
Erase Inspire	27
Troubleshooting	29
Unresponsive device	29
General Info and Specifications	30
Sensors and Components	30
Materials	30
Wireless technology	30
Haptic feedback	30
Battery	30
Memory	31
Display	31
Band size	31
Environmental conditions	31
Learn more	32
Return policy and warranty	32
Regulatory and Safety Notices	33
USA: Federal Communications Commission (FCC) statement	33
Canada: Industry Canada (IC) statement	34
European Union (EU)	35
Argentina	36

Australia and New Zealand	37
China	37
India	39
Israel	39
Japan	39
Mexico	39
Morocco	40
Nigeria	40
Oman	40
Pakistan	41
Philippines	41
Serbia	41
South Korea	42
Taiwan	42
United Arab Emirates	44
Zambia	45
Safety Statement	45

Get started

Fitbit Inspire is a friendly fitness tracker for every day that helps you build healthy habits.

Take a moment to review our complete safety information at [fitbit.com/safety](https://www.fitbit.com/safety). Inspire is not intended to provide medical or scientific data.

What's in the box

Your Inspire box includes:



Tracker with small band
(color and material vary)



Charging cable



Additional large band
(color and material vary)

The detachable bands on Inspire come in a variety of colors and materials, sold separately.

Charge your tracker

A fully-charged Inspire has a battery life of 5 days. Battery life and charge cycles vary with use and other factors; actual results will vary.

To charge Inspire:

1. Plug the charging cable into the USB port on your computer, a UL-certified USB wall charger, or another low-energy charging device.
2. Hold the other end of the charging cable near the port on the back of the tracker until it attaches magnetically. Make sure the pins on the charging cable align with the port on the back of your tracker.

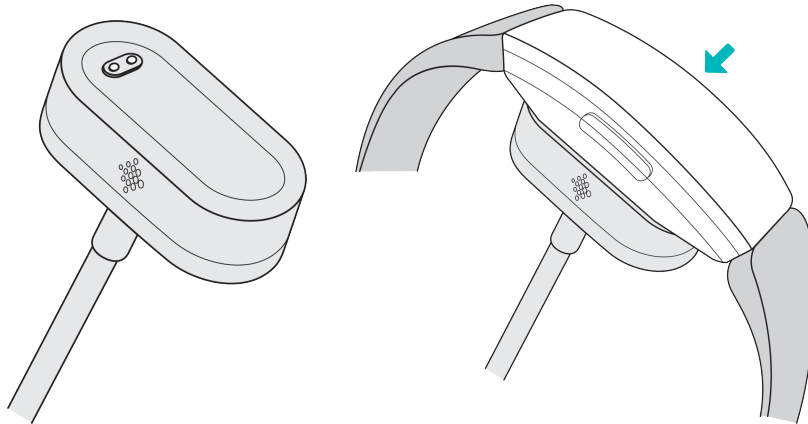

Charging fully takes about 1-2 hours. While the tracker charges, you can press the buttons to check the battery level. A fully-charged tracker shows a solid battery icon with a smile.

Set up with your phone

Set up Inspire with the Fitbit app for iPhones and iPads or Android phones. The Fitbit app is compatible with most popular phones. See [fitbit.com/devices](https://www.fitbit.com/devices) to check if your phone is compatible.



To get started:

1. Download the Fitbit app:
 - [Apple App Store](#) for iPhones
 - [Google Play Store](#) for Android phones
2. Install the app, and open it.
3. Tap **Sign in with Google**, and follow the on-screen instructions to set up your device.

When you're done with setup, read through the guide to learn more about your new tracker and then explore the Fitbit app.

For more information, see [the related help article](#).

See your data in the Fitbit app

Open the Fitbit app on your phone to see your activity and sleep data, choose a workout or mindfulness session, and more.

Wear Inspire

Choose to wear Inspire around your wrist or in the clip accessory (sold separately). If you need to remove the band or attach a different band, see the instructions in ["Change the band" on page 12.](#)

When you wear Inspire in the band, make sure your tracker is set to **On Wrist** .

When you wear Inspire in the accessory clip, make sure it's set to **On Clip** . For more information, see ["Navigate Inspire" on page 14.](#)

Wear Inspire on your wrist

Wear Inspire a finger's width above your wrist bone. Attach the bands, and then securely fasten your tracker on your wrist. For more information, see ["Change the band" on page 12.](#)

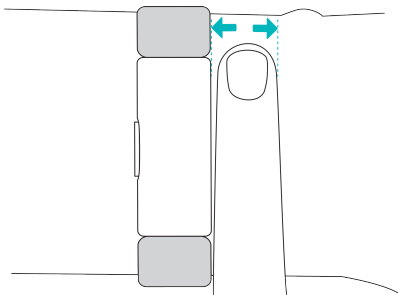

Secure the band

1. If you previously wore Inspire in a clip, change your device setting to On Wrist. For more information, see ["Navigate Inspire" on page 14.](#)
2. Place Inspire around your wrist.
3. Slide the end of the band with the peg through the loop.
4. Align both ends of the band so they directly overlap, and choose the hole that best fits your wrist.

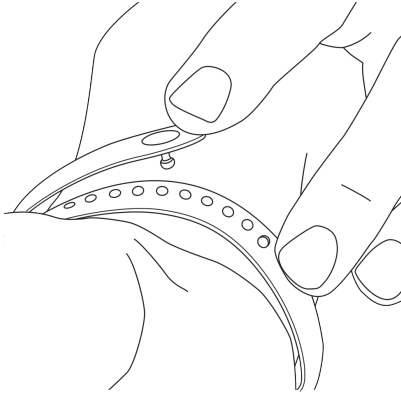

5. Squeeze the peg and band between your thumb and forefinger until you feel the band snap into place. Don't wear your tracker too tightly.

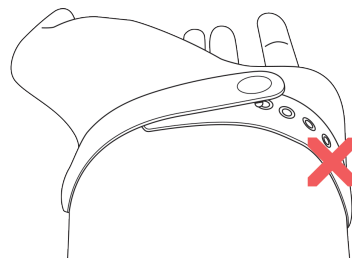
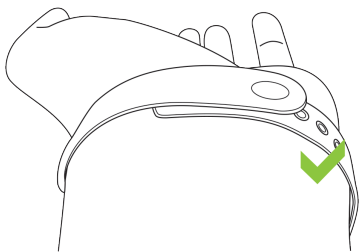
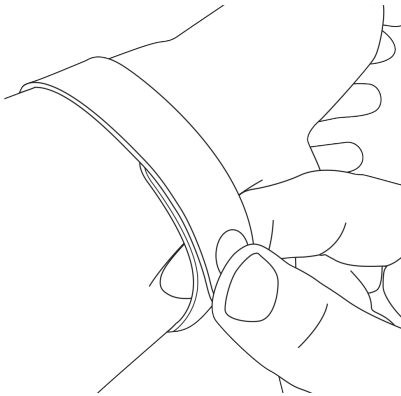

Handedness



For greater accuracy, you must specify whether you wear Inspire on your dominant or non-dominant hand. Your dominant hand is the one you use for writing and eating. To start, the Wrist setting is set to non-dominant. If you wear Inspire on your dominant hand, change the Wrist setting in the Fitbit app:

From the Today tab  in the Fitbit app, tap the icon in the top left > Inspire tile > **Wrist** > **Dominant**.

Wear Inspire in a clip

Wear Inspire clipped to your clothing. Remove the bands, and place your tracker in the clip. For more information, see ["Change the band" on page 12](#).

To put Inspire in the clip:

1. If you previously wore Inspire on your wrist, change your device setting to **On Clip** . For more information, see ["Navigate Inspire" on page 14](#). **Note:** Make sure Inspire is set to **On Wrist**  when you wear your tracker in the band.
2. Hold the tracker with the screen facing you and the button on the left.
3. Hold the clip accessory with the opening facing you and the button insert on the left.
4. Place the top of the tracker into the clip opening and move the bottom of the tracker into place. Inspire is secure when all edges of the clip lie flat against the tracker.

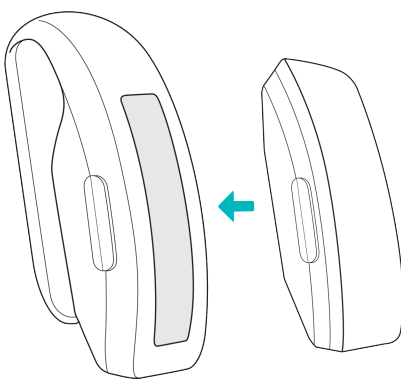

Clip Placement

Wear Inspire on or close to your body with the screen facing outward. Secure the clip tightly to a shirt pocket, bra, pants pocket, belt, or waistband. Try out a few different locations to see what's most comfortable and secure for you.

If you experience skin irritation when wearing Inspire on your bra or waistband, clip it to an external piece of clothing instead, such as your belt or pocket.

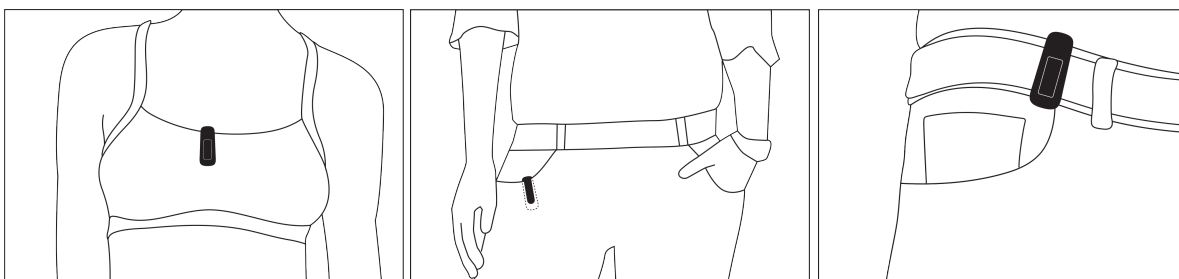

Wear and care tips

- Clean your band and wrist regularly with a soap-free cleanser.
- If your tracker gets wet, remove and dry it completely after your activity.
- Take your tracker off from time to time.

For more information, visit the [Fitbit Wear & Care page](#).

Change the band

Inspire comes with a small band attached and an additional large, bottom band in the box. Both the top and bottom bands can be swapped with accessory bands, sold separately on [fitbit.com](https://www.fitbit.com). For band measurements, see "Band size" on page 31.

Fitbit Inspire and Fitbit Inspire HR bands are compatible with both trackers.

Remove a band

1. Turn over Inspire and find the quick-release lever.
2. While pressing the quick-release lever inward, gently pull the band away from the tracker to release it.

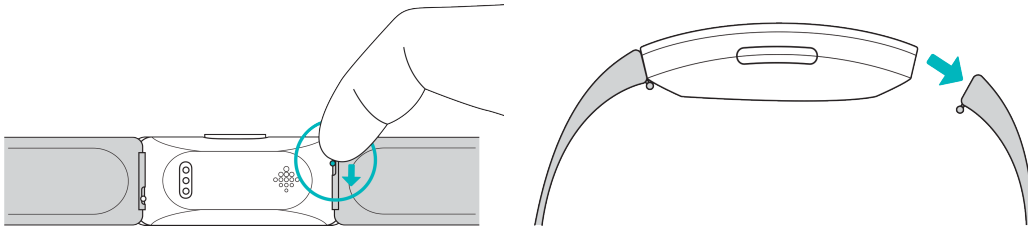

3. Repeat on the other side.

Attach a band

1. To attach a band, hold the band and slide the pin (the side opposite the quick-release lever) into the notch on the tracker.

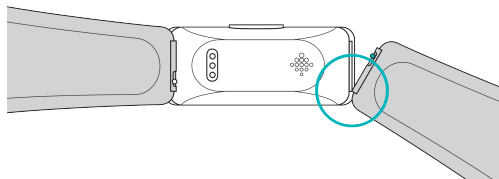

2. While pressing the quick-release lever inward, slide the other end of the band into place.

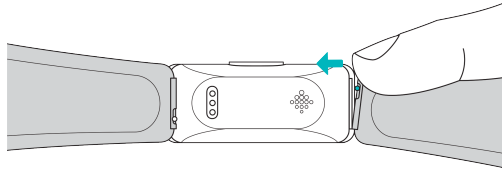

3. When both ends of the pin are inserted, release the quick-release lever.

Basics

Learn how to navigate, check the battery level, and care for your tracker.

Navigate Inspire

Inspire has an OLED touchscreen display and 1 button.

Navigate Inspire by tapping the screen, swiping up and down, or pressing the buttons. To preserve battery, the tracker's screen turns off when not in use.

Basic navigation

The home screen is the clock.

- Swipe down to scroll through the apps on Inspire. Tap an app to open it.
- Swipe up to see your daily stats.





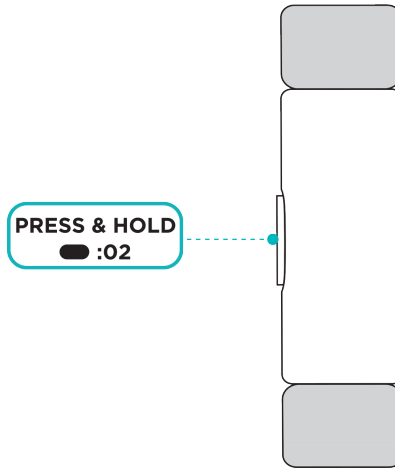

Quick settings

Press and hold the buttons on Inspire for a faster way to access certain settings. Tap a setting to turn it on or off. When you turn off the setting, the icon appears dim with a line through it.



On the quick settings screen:

Battery	Check the battery level.
On Wrist  / On Clip  setting	When Inspire is on your wrist, make sure the tracker is set to On Wrist  . When Inspire is in the clip, make sure the tracker is set to On Clip  .
Screen Wake	When the screen wake setting is on, turn your wrist toward you to turn on the screen.
Notifications	When the notifications setting is on, Inspire displays notifications from your phone when your phone is nearby. For more information, see "Notifications from your phone" on page 18.

Change the clock face

The Fitbit Gallery offers a variety of clock faces to personalize your tracker.

1. From the Today tab  in the Fitbit app, tap the icon in the top left > Inspire tile.
2. Tap **Gallery** > **Clocks** tab.
3. Browse the available clock faces. Tap a clock face to see a detailed view.
4. Tap **Install** to add the clock face to Inspire.

Notifications from your phone

Inspire can show call, text, calendar, and app notifications from your phone to keep you informed. Keep your tracker within 30 feet of your phone to receive notifications. Up to 10 notifications are stored in the Notifications app  on your tracker.

Set up notifications

Check that Bluetooth on your phone is on and that your phone can receive notifications (often under Settings > Notifications). Then set up notifications:

1. From the Today tab  in the Fitbit app, tap the icon in the top left > Inspire tile.
2. Tap **Notifications**.
3. Follow the on-screen instructions to pair your tracker if you haven't already. Call, text, and calendar notifications are turned on automatically.
4. To turn on notifications from apps installed on your phone, including Fitbit and WhatsApp, tap **App Notifications** and turn on the notifications you want to see.

Note that if you have an iPhone, Inspire shows notifications from all calendars synced to the Calendar app. If you have an Android phone, Inspire shows calendar notifications from the calendar app you chose during setup.

For more information, see [the related help article](#).

See incoming notifications

When your phone and Inspire are within range, a notification causes the tracker to vibrate.

- Phone calls—the name or number of the caller scrolls once. Press the buttons to dismiss the notification.

- Text messages—the name of the sender scrolls once above the message. Swipe up to read the full message.
- Calendar alerts—the name of the event scrolls once below the time and location.
- App notifications—the name of the app or sender scrolls once above the message. Swipe up to read the full message.

To read a notification later, swipe down from the clock face, and tap the Notifications app . Tap a notification to expand the message.

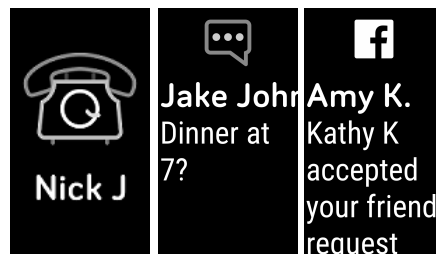

Note: Your tracker shows the first 250 characters of the notification. Check your phone for the full message.

Turn off notifications

Turn off certain notifications in the Fitbit app, or turn off all notifications in quick settings on Inspire. When you turn off all notifications, your tracker won't vibrate and the screen won't turn on when your phone receives a notification.

To turn off certain notifications:

1. From the Today tab  in the Fitbit app on your phone, tap the icon in the top left > Inspire tile > **Notifications**.
2. Turn off the notifications you no longer want to receive on your tracker.

To turn off all notifications:

1. Press and hold the button on your tracker to reach the quick settings screen.
2. Tap **Notifications** to turn them off.

Note that if you use the do not disturb setting on your phone, you don't receive notifications on your tracker until you turn off this setting.

Timekeeping

Alarms vibrate to wake or alert you at a time you set. Set up to 8 alarms to occur once or on multiple days of the week. You can also time events with the stopwatch or set a countdown timer.

Set an alarm

Set and delete alarms in the Fitbit app. Turn alarms on or off directly on Inspire in the Alarms app  .

For more information, see [the related help article](#).

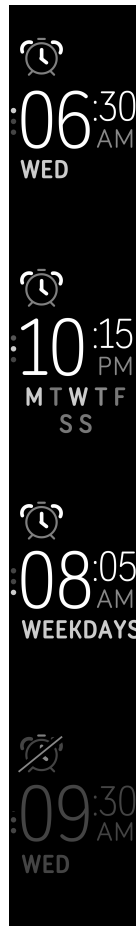

Dismiss or snooze an alarm

When an alarm goes off, the tracker vibrates. To dismiss the alarm, press the buttons. To snooze the alarm for 9 minutes, swipe down.

Snooze the alarm as many times as you want. Inspire automatically goes into snooze mode if you ignore the alarm for more than 1 minute.



Use the timer or stopwatch

Time events with the stopwatch or set a countdown timer with the Timers app  on your tracker. You can run the stopwatch and countdown timer at the same time.

For more information, see [the related help article](#).

Activity and Wellness

Inspire continuously tracks a variety of stats whenever you wear it. Data automatically syncs with the Fitbit app throughout the day.

See your stats

Swipe up from the clock face to see your daily stats, including:

Core stats	Steps taken today, distance covered, calories burned, and active minutes
Hourly steps	Steps taken this hour, and the number of hours you met your hourly activity goal (tap to switch between these stats)
Cycle track	Information on the current stage of your menstrual cycle, if applicable
Sleep	Sleep duration
Water	Water intake logged today
Weight	Current weight, progress toward your weight goal, or where your weight falls within a healthy range if your goal is to maintain your weight

If you set a goal in the Fitbit app, a ring shows your progress toward that goal.

Find your complete history and other information detected by your tracker in the Fitbit app.

For more information, see [the related help article](#).

Track a daily activity goal

Inspire tracks your progress toward a daily activity goal of your choice. When you reach your goal, your tracker vibrates and shows a celebration.

Choose a goal

Set a goal to help you get started on your health and fitness journey. To begin, your goal is to take 10,000 steps per day. Choose to change the number of steps, or pick a different activity goal.

For more information, see [the related help article](#).

Track progress toward your goal on Inspire. For more information, see "[See your stats](#)" on the previous page.

Track your hourly activity

Inspire helps you stay active throughout the day by keeping track of when you're stationary and reminding you to move.

Reminders nudge you to walk at least 250 steps each hour. You feel a vibration and see a reminder on your screen at 10 minutes before the hour if you haven't walked 250 steps. When you meet the 250-step goal after receiving the reminder, you feel a second vibration and see a congratulatory message.



For more information, see [the related help article](#).

Track your exercise automatically

Inspire automatically recognizes and records many high-movement activities which are at least 15 minutes long. See basic stats about your activity in the Fitbit app on

your phone. From the Today tab  , tap the Exercise tile  .

For more information, see [the related help article](#).

Track your sleep

Wear Inspire to bed to automatically track your time asleep and movement during the night to help you understand your sleep patterns. Sync your tracker when you wake up and check the Fitbit app to see your sleep stats, including when you go to bed, how long you're asleep, and how long you spend awake or restless.

For more information, see [the related help article](#).

Set a sleep goal

To start, you have a sleep goal of 8 hours of sleep per night. Customize this goal to meet your needs.

For more information, see [the related help article](#).

Learn about your sleep habits

With a Fitbit Premium subscription, get tips to help you build a better sleep routine and wake up feeling refreshed.

For more information, see [the related help article](#).

Update, Restart, and Erase

Learn how to update, restart, and erase Inspire.

Update Inspire

Update your tracker to get the latest feature enhancements and product updates.

When an update is available, a notification appears in the Fitbit app. After you start the update, follow the progress bars on Inspire and in the Fitbit app until the update is complete. Keep your tracker and phone close to each other during the update.

Updating Inspire takes several minutes and may be demanding on the battery. We recommend plugging your tracker into the charger before starting the update.

For more information, see [the related help article](#).

Restart Inspire

If you can't sync Inspire, don't see your stats, or your tracker is unresponsive, restart your device:

1. Connect Inspire to the charging cable. For instructions, see "[Charge your tracker](#)" on page 5.
2. Press and hold the buttons on your tracker for 5 seconds. Release the buttons. When you see a smiley face and Inspire vibrates, the tracker restarted.

Restarting your tracker doesn't delete any data.

Erase Inspire

If you want to give Inspire to another person or wish to return it, first clear your personal data:

1. On Inspire, open the Settings app  > **Clear User Data**.
2. When prompted, press the screen for 3 seconds, then release. When Inspire vibrates and you see the clock screen, your data is erased.

Troubleshooting

If Inspire isn't working properly, see our troubleshooting steps below.

Unresponsive device

If you experience any of the following issues, restart your tracker:

- Won't sync
- Won't respond to taps, swipes, or button press
- Won't track steps or other data
- Won't show notifications

For instructions, see ["Restart Inspire" on page 27](#).

General Info and Specifications

Sensors and Components

Fitbit Inspire contains a MEMS 3-axis accelerometer, which tracks motion patterns.

Materials

The housing on Inspire is plastic. The Inspire classic band is made of a flexible, durable elastomer material similar to that used in many sports watches, and the peg is made of anodized aluminum. While anodized aluminum can contain traces of nickel, which can cause an allergic reaction in someone with nickel sensitivity, the amount of nickel in all Fitbit products meets the European Union's stringent Nickel Directive.

Wireless technology

Inspire contains a Bluetooth 4.0 radio transceiver.

Haptic feedback

Inspire contains a vibration motor for alarms, goals, notifications, and reminders.

Battery

Inspire contains a rechargeable lithium-polymer battery.

Memory

Inspire stores your data, including daily stats, sleep information, and exercise history, for 7 days. See your historical data in the Fitbit app.

Display

Inspire has an OLED display.

Band size

Band sizes are shown below. Note that accessory bands sold separately may vary slightly.

Small band	Fits a wrist between 5.5 - 7.1 inches (140 mm - 180 mm) in circumference
Large band	Fits a wrist between 7.1 - 8.7 inches (180 mm - 220 mm) in circumference

Environmental conditions

Operating temperature	14° to 113° F (-10° to 45° C)
Non-operating temperature	-4° to 14° F (-20° to -10° C) 113° to 140°F (45° to 60° C)
Water resistance	Water resistant up to 50 meters
Maximum operating altitude	28,000 feet (8,534 m)

Learn more

To learn more about your tracker, how to track your progress in the Fitbit app, and how to build healthy habits with Fitbit Premium, visit help.fitbit.com.

Return policy and warranty

Find warranty information and the fitbit.com return policy on [our website](#).

Regulatory and Safety Notices

Notice to the User: Regulatory content for select regions for FB412 can also be viewed on your device. To view the content: Settings > Device Info.

USA: Federal Communications Commission (FCC) statement

Model FB412

FCC ID: XRAFB412

Notice to the User: The FCC ID can also be viewed on your device. To view the content:

Settings > Device Info

Unique Identifier: FB412

Responsible Party – U.S. Contact Information

199 Fremont Street, 14th Floor
San Francisco, CA
94105
United States
877-623-4997

www.fitbit.com

FCC Compliance Statement (for products subject to Part 15)

This device complies with Part 15 of the FCC Rules.

Operation is subject to the following two conditions:

1. This device may not cause harmful interference and
2. This device must accept any interference, including interference that may cause undesired operation of the device.

FCC Warning

Changes or modifications not expressly approved by the party responsible for compliance could void the user's authority to operate the equipment.

Note: This equipment has been tested and found to comply with the limits for a Class B digital device, pursuant to part 15 of the FCC Rules. These limits are designed to provide reasonable protection against harmful interference in a residential installation. This equipment generates, uses and can radiate radio frequency energy and, if not installed and used in accordance with the instructions, may cause harmful interference to radio communications. However, there is no guarantee that interference will not occur in a particular installation. If this equipment does cause harmful interference to radio or television reception, which can be determined by turning the equipment off and on, the user is encouraged to try to correct the interference by one or more of the following measures:

- Reorient or relocate the receiving antenna.
- Increase the separation between the equipment and receiver.
- Connect the equipment into an outlet on a circuit different from that to which the receiver is connected.
- Consult the dealer or an experienced radio/TV technician for help.

This device meets the FCC and IC requirements for RF exposure in public or uncontrolled environments.

Canada: Industry Canada (IC) statement

Model/Modèle FB412

IC: 8542A-FB412

Notice to the User: The IC ID can also be viewed on your device. To view the content:

Settings > Device Info

Paramètres > Informations sur l'appareil

This device meets the IC requirements for RF exposure in public or uncontrolled environments.

Cet appareil est conforme aux conditions de la IC en matière de RF dans des environnements publics ou incontrôlée

IC Notice to Users English/French in accordance with current issue of RSS GEN:

This device complies with Industry Canada license exempt RSS standard(s).

Operation is subject to the following two conditions:

1. this device may not cause interference, and
2. this device must accept any interference, including interference that may cause undesired operation of the device.

Cet appareil est conforme avec Industrie Canada RSS standard exempts de licence (s). Son utilisation est soumise à Les deux conditions suivantes:

1. cet appareil ne peut pas provoquer d'interférences et
2. cet appareil doit accepter Toute interférence, y compris les interférences qui peuvent causer un mauvais fonctionnement du dispositif

European Union (EU)

Model FB412

Simplified EU Declaration of Conformity

Hereby, Fitbit, Inc. declares that the radio equipment type Model FB412 is in compliance with Directive 2014/53/EU. The full text of the EU declaration of conformity is available at the following internet address: www.fitbit.com/safety

Vereinfachte EU-Konformitätserklärung

Fitbit, Inc. erklärt hiermit, dass die Funkgerätypen Modell FB412 die Richtlinie 2014/53/EU erfüllen. Der vollständige Wortlaut der EU-Konformitätserklärungen kann unter folgender Internetadresse abgerufen werden: www.fitbit.com/safety

Declaración UE de Conformidad simplificada

Por la presente, Fitbit, Inc. declara que el tipo de dispositivo de radio Modelo FB412 cumple con la Directiva 2014/53/UE. El texto completo de la declaración de conformidad de la UE está disponible en la siguiente dirección de Internet: www.fitbit.com/safety

Déclaration UE de conformité simplifiée

Fitbit, Inc. déclare par la présente que les modèles d'appareils radio FB412 sont conformes à la Directive 2014/53/UE. Les déclarations UE de conformité sont disponibles dans leur intégralité sur le site suivant : www.fitbit.com/safety

Dichiarazione di conformità UE semplificata

Fitbit, Inc. dichiara che il tipo di apparecchiatura radio Modello FB412 è conforme alla Direttiva 2014/53/UE. Il testo completo della dichiarazione di conformità UE è disponibile al seguente indirizzo Internet: www.fitbit.com/safety



Argentina

Model FB412:



RAMATEL

C-22555

Australia and New Zealand



China

Regulatory content can also be viewed on your device. To view the content:

Settings > Device Info

Model FB412:

Frequency band: 2400-2483.5

Transmitted power: Max EIRP, 6.3dBm

Occupied bandwidth: 2MHz

Modulation system: GFSK

CMIIT ID displayed: On packaging

CMIT ID: 2018DJ9012

China RoHS

部件名称 Part Name	有毒和危险品 Toxic and Hazardous Substances or Elements					
	铅 (Pb)	水银 (Hg)	镉 (Cd)	六价铬 (Cr(VI))	多溴化苯 (PBB)	多溴化二苯 醚 (PBDE)
Model FB412						
表带和表扣 (Strap and Buckle)	○	○	○	○	○	○
电子 (Electronics)	--	○	○	○	○	○
电池 (Battery)	○	○	○	○	○	○
充电线 (Charging Cable)	○	○	○	○	○	○

本表格依据 SJ/T 11364 的规定编制

○ = 表示该有害物质在该部件所有均质材料中的含量均在 GB/T 26572规定的限量要求以下 (indicates that the content of the toxic and hazardous substance in all the Homogeneous Materials of the part is below the concentration limit requirement as described in GB/T 26572).

X = 表示该有害物质至少在该部件的某一均质材料中的含量超出 GB/T 26572规定的限量要求 (indicates that the content of the toxic and hazardous substance in at least one Homogeneous Material of the part exceeds the concentration limit requirement as described in GB/T 26572).



India

Model FB412

Notice to the User: Regulatory content for this region can also be viewed on your device. To view the content:

Settings > **Device Info**

Israel

Model FB412

התאמה אישור 55-01198

המוצר של המודולארי בחלק טכני שינוי כל לבצע אין.

Japan

Model FB412

Notice to the User: Regulatory content for this region can also be viewed on your device. To view the content:

Settings > **Device Info**



201-180693

Mexico

Model FB412



La operación de este equipo está sujeta a las siguientes dos condiciones:

1. Es posible que este equipo o dispositivo no cause interferencia perjudicial y
2. Este equipo o dispositivo debe aceptar cualquier interferencia, incluyendo la que pueda causar su operación no deseada

Morocco

Model FB412

AGREE PAR L'ANRT MAROC

Numéro d'agrément: MR 18210 ANRT 2018

Date d'agrément: 11/12/2018

Nigeria

Model Name FB412

Connection and use of this communications equipment is permitted by the Nigerian Communications Commission.

Oman

Model FB412

D090258

TRA/TA-R/6790/19

Pakistan

Model No.: FB412

TAC No: 9.6044/2018



Model: FB412

Serial No: Refer to retail box

Year of Manufacture: 2018

Philippines

Model FB412



Serbia

Model FB412



South Korea

Model FB412

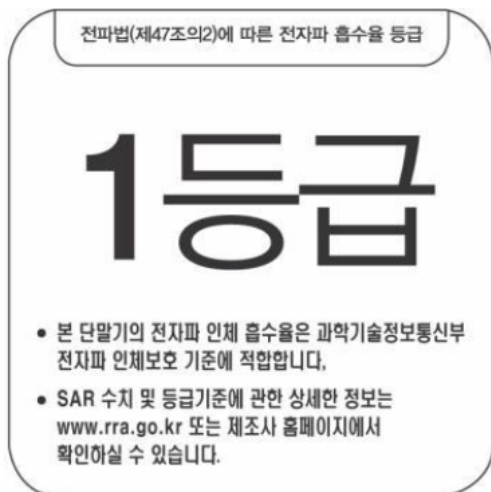

클래스 B 장치 (가정 사용을 위한 방송 통신 기기): EMC 등록 주로 가정용 (B 급)으로하고, 모든 지역에서 사용할 수 있습니다 얻을이 장치.

" 해당 무선설비는 전파혼신 가능성이 있으므로 인명안전과 관련된 서비스는 할 수 없습니다. "

Taiwan

Model FB412



CCAF19LP0010T1

低功率警語:

依據 低功率電波輻射性電機管理辦法

第十二條

經型式認證合格之低功率射頻電機, 非經許可, 公司、商號或使用者均不得擅自變更頻率、加大功率或變更原設計之特性及功能

第十四條

低功率射頻電機之使用不得影響飛航安全及干擾合法通信; 經發現有干擾現象時, 應立即停用, 並改善至無干擾時方得繼續使用。

前項合法通信, 指依電信法規定作業之無線電通信。低功率射頻電機須忍受合法通信或工業、科學及醫療用電波輻射性電機設備之干擾

Translation:

Low power warning:

According to the management method of low power radio wave radiating motor.

Article 12

Low-power RF motors that have passed the type certification are not allowed to change the frequency, increase the power or change the characteristics and functions of the original design without permission.

Article 14

The use of low-power RF motors shall not affect flight safety and interfere with legal communications; if interference is found, it shall be immediately deactivated and improved until no interference is required.

Legal communication in the preceding paragraph refers to radio communications operating in accordance with the provisions of the Telecommunications Act. Low-power RF motors must withstand interference from legitimate communications or radiological electrical equipment for industrial, scientific, and medical use.

使用過度恐傷害視力」

使用30分鐘請休息10分鐘。2歲以下幼兒不看螢幕，2歲以上每天看螢幕不要超過1小時。

Translation:

“Excessive use may cause damage to vision”

Rest for 10 minutes after every 30 minutes.

Children under 2 years old should stay away from this product. Children 2 years old or more should not see the screen for more than 1 hour.

電池警語：

此裝置使用鋰電池。

若未遵照下列準則，則裝置內的鋰離子電池壽命可能會縮短或有損壞裝置、發生火災、化學品灼傷、電解液洩漏及 / 或受傷的風險。

Translation:

Battery warning:

This device uses a lithium-ion battery.

If the following guidelines are not followed, the life of the lithium-ion battery in the device may be shortened or there is a risk of damage to the device, fire, chemical burn, electrolyte leakage and / or injury.

United Arab Emirates

Model FB412

TRA Registered No.: ER68013/18
Dealer No: 35294/14

Zambia

Model FB412



ZMB / ZICTA / TA / 2019 / 1 / 3

Safety Statement

This equipment has been tested to comply with safety certification in accordance with the specifications of EN Standard: EN60950-1:2006 + A11:2009 + A1:2010 + A12:2011 + A2:2013 & EN62368-1:2014 + A11:2017.

©2023 Fitbit LLC. All rights reserved. Fitbit and the Fitbit logo are trademarks or registered trademarks of Fitbit in the US and other countries. A more complete list of Fitbit trademarks can be found at the [Fitbit Trademark List](#). Third-party trademarks mentioned are the property of their respective